

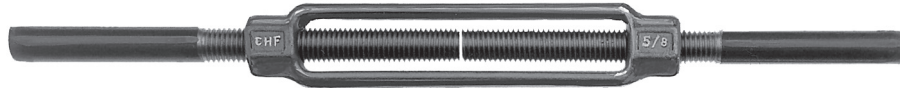

DROP FORGED TURNBUCKLES



(Class C)



(Class B)



(Class B)

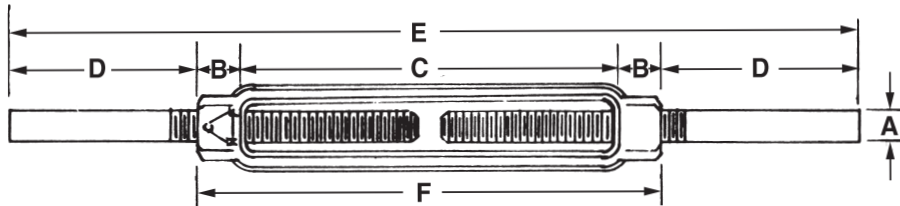

Turnbuckles Meet Performance Requirements of ASTM Specification F1145-92 Type 1 Grade 1 (Supercedes FF-T-791B)

Diameter & Take-up	Body Only						Body and Stubs					Working Load Limit in Lbs.
	Drilled & Tapped		Overall Length (F)	Weight per 100 D&T	Blanks		SC Part No.	Dimensions - Inches			Weight per 100	
	SC Part No.	Galv. Part No.			SC Part No.	Galv. Part No.		B	D	E		
1/4" x 4"	03805 8	03955 0	4-13/16"	14	00105 2	00255 4	04105 8	13/32"	2-5/8"	10"	25	500
5/16" x 4-1/2"	03810 2	03960 4	5-9/16"	21.5	00110 6	00260 8	04110 2	1-7/32"	2-25/32"	11"	42.5	800
3/8" x 6"	03815 7	03965 9	7-1/8"	37.5	00115 1	00265 3	04115 7	9/16"	4-7/16"	16"	85	1200
1/2" x 2"	03820 1	03970 3	3-1/2"	34	00120 5	00270 7	04120 1	3/4"	3-1/4"	10-1/4"	84	2200
1/2" x 6"	03823 2	03973 4	7-1/2"	66	00123 6	00273 8	04123 2	3/4"	4-1/4"	16"	142.5	2200
1/2" x 9"	03826 3	03976 5	10-1/2"	84.5	00126 7	00276 9	04126 3	3/4"	4-1/4"	19"	170	2200
1/2" x 12"	03829 4	03979 6	13-1/2"	102	00129 8	00279 0	04129 4	3/4"	4-1/4"	22"	200	2200
5/8" x 6"	03834 8	03984 0	7-7/8"	90.5	00134 2	00284 4	04134 8	15/16"	4-1/16"	16"	212.5	3500
5/8" x 9"	03837 9	03987 1	10-7/8"	131	00137 3	00287 5	04137 9	15/16"	4-1/16"	19"	285	3500
5/8" x 12"	03840 9	03990 1	13-7/8"	172.5	00140 3	00290 5	04140 9	15/16"	4-1/16"	22"	317.5	3500
5/8" x 18"	03843 0	03993 2	20-1/4"	345	00143 4	00293 6	04143 0	15/16"	4-1/16"	28"	577.5	3500
3/4" x 6"	03848 5	03998 7	8-1/4"	129	00148 9	00298 1	04148 5	1-1/8"	4-3/8"	17"	320	5200
3/4" x 9"	03851 5	04001 3	11-1/4"	191	00151 9	00301 8	04151 5	1-1/8"	4-3/8"	20"	412.5	5200
3/4" x 12"	03854 6	04004 4	14-1/4"	243	00154 0	00304 9	04154 6	1-1/8"	4-3/8"	23"	497.5	5200
3/4" x 18"	03857 7	04007 5	20-1/4"	336.5	00157 1	00307 0	04157 7	1-1/8"	4-3/8"	29"	677.5	5200
7/8" x 6"	03862 1	04012 9	8-5/8"	196	00162 5	00312 4	04162 1	1-5/16"	4-11/16"	18"	467.5	7200
7/8" x 12"	03865 2	04015 0	14-5/8"	309.5	00165 6	00315 5	04165 2	1-5/16"	4-11/16"	24"	661	7200
7/8" x 18"	03868 3	04018 1	20-5/8"	583.5	00168 7	00318 6	04168 3	1-5/16"	4-11/16"	30"	1039	7200
1" x 6"	03873 7	04023 5	9"	279	00173 1	00323 0	04173 7	1-1/2"	5"	19"	610	9800
1" x 12"	03876 8	04026 6	15"	383	00176 2	00326 1	04176 8	1-1/2"	5"	25"	920	9800
1" x 18"	03879 9	04029 7	21"	566	00179 3	00329 2	04179 9	1-1/2"	5"	31"	1176.5	9800
1-1/8" x 6"	03884 3	04034 1	9"	228	00184 7	00334 6	04184 3	1-11/16"	4-5/8"	19"	693	11500
1-1/8" x 12"	03887 4	04037 2	15"	467.5	00187 8	00337 7	04187 4	1-11/16"	4-5/8"	25"	1017.5	11500
1-1/4" x 6"	03892 8	04042 6	9-3/4"	449	00192 2	00342 1	04192 8	1-7/8"	5-1/8"	20"	1093	14800
1-3/8" x 6"	03897 3	04047 1	9-3/4"	430	00197 7	00347 6	04197 3	2-3/16"	5-1/2"	20-1/2"	1195	17500
1-1/2" x 6"	03902 4	04052 5	10-3/8"	684	00202 8	00352 0	04202 4	2-3/16"	5-1/2"	20-1/2"	1580	21000

Maximum load ratings are based on a straight vertical lift in a gradually increasing manner. Any deviations as angular lifts, shock loads, modification of the basic part, etc., will result in drastically reduced maximum loads.



DROP FORGED TURNBUCKLES



Turnbuckles Meet Performance Requirements of ASTM Specification F1145-92 Type 1 Grade 1
(Supersedes FF-T-791B)

Available with hot galvanized or self-colored finish.



Diameter & Take-up	Eye and Eye			Hook and Hook			Weight per 100 in Lbs.
	Part No.		Closed Length	Part No.		Closed Length	
	SC	Galv.		SC	Galv.		
1/4" x 4"	01105 1	01255 3	8"	02005 3	02155 5	8-1/2"	35
5/16" x 4-1/2"	01110 5	01260 7	9"	02010 7	02160 9	9-1/2"	47.5
3/8" x 6"	01115 0	01265 2	11-1/2"	02015 2	02165 4	12"	90.6
1/2" x 2"	01120 4	01270 6	8-1/2"	02020 6	02170 8	10"	111
1/2" x 6"	01123 5	01273 7	13"	02023 7	02173 9	14-1/4"	170
1/2" x 9"	01126 6	01276 8	16"	02026 8	02176 0	17-1/4"	202
1/2" x 12"	01129 7	01279 9	19"	02029 9	02179 1	20-1/4"	232.5
5/8" x 6"	01134 1	01284 3	13-1/2"	02034 3	02184 5	14-3/4"	260
5/8" x 9"	01137 2	01287 4	17"	02037 4	02187 6	17-3/4"	320
5/8" x 12"	01140 2	01290 4	20-1/2"	02040 4	02190 6	20-3/4"	392.5
5/8" x 18"	01143 3	01293 5	26-1/2"	02043 5	02193 7	26-3/4"	557
3/4" x 6"	01148 8	01298 0	14-3/4"	02048 0	02198 2	16-3/4"	397.5
3/4" x 9"	01151 8	01301 7	18"	02051 0	02201 9	19-3/4"	512.5
3/4" x 12"	01154 9	01304 8	21-3/4"	02054 1	02204 0	22-3/4"	581
3/4" x 18"	01157 0	01307 9	27-3/4"	02057 2	02207 1	28-3/4"	666
7/8" x 6"	01162 4	01312 3	18"	02062 6	02212 5	19"	650
7/8" x 12"	01165 5	01315 4	22-1/2"	02065 7	02215 6	23-3/4"	787.5
7/8" x 18"	01168 6	01318 5	28-1/2"	02068 8	02218 7	29-3/4"	1212
1" x 6"	01173 0	01323 9	17"	02073 2	02223 1	20"	805
1" x 12"	01176 1	01326 0	25"	02076 3	02226 2	25-1/2"	1077.5
1" x 18"	01179 2	01329 1	31"	02079 4	02229 3	31-1/2"	1386

(Class D)

(Class E)

To ascertain extended length add amount of take-up to length in closed position.

Eye, Jaw and Hook fittings are heat treated.

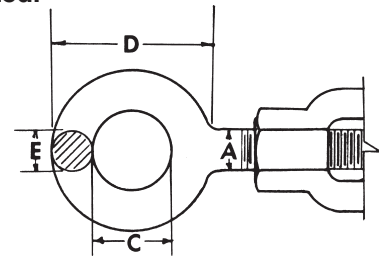
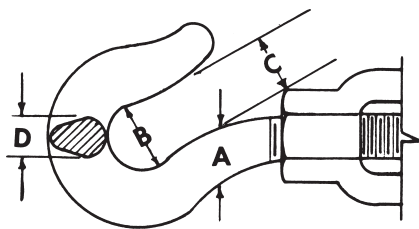

Hook

Dimensions – Inches				Working Load Limit in Lbs.†
A	B	C	D	
1/4"	5/16"	9/32"	7/32"	400
5/16"	1/2"	1/2"	5/16"	700
3/8"	1/2"	1/2"	3/8"	1,000
1/2"	7/8"	13/16"	17/32"	1,500
5/8"	29/32"	27/32"	5/8"	2,250
3/4"	1-1/8"	29/32"	11/16"	3,000
7/8"	1-3/16"	1-1/16"	13/16"	3,200
1"	1-3/8"	1-1/4"	7/8"	5,000

Eye

Dimensions – Inches				Working Load Limit in Lbs.†
A	C	D	E	
1/4"	1/2"	1"	7/32"	500
5/16"	5/8"	1-1/4"	9/32"	800
3/8"	3/4"	1-1/2"	11/32"	1,200
1/2"	1"	2"	7/16"	2,200
5/8"	1-1/4"	2-5/16"	17/32"	3,500
3/4"	1-1/2"	2-3/4"	5/8"	5,200
7/8"	1-3/4"	3-1/2"	7/8"	7,200
1"	2"	3-3/4"	7/8"	10,000

† Loads are based on a safety factor of 5 to 1. Maximum load ratings are based on a straight vertical lift in a gradually increasing manner. Any deviations as angular lifts, shock loads, modification of the basic part, etc., will result in drastically reduced maximum loads.



DROP FORGED TURNBUCKLES

Turnbuckles Meet Performance Requirements of ASTM Specification F1145-92 Type 1 Grade 1 (Supercedes FF-T-791B)



(Class F)

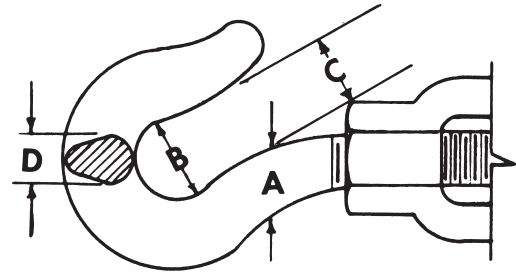

HOOK DIMENSIONS - STRENGTH

Dimensions - Inches				Working Load Limit in Lbs. †
A	B	C	D	
1/4"	5/16"	9/32"	7/32"	400
5/16"	1/2"	1/2"	5/16"	700
3/8"	1/2"	1/2"	3/8"	1,000
1/2"	7/8"	13/16"	17/32"	1,500
5/8"	29/32"	27/32"	5/8"	2,250
3/4"	1-1/8"	29/32"	11/16"	3,000
7/8"	1-3/16"	1-1/16"	13/16"	3,200
1"	1-3/8"	1-1/4"	7/8"	5,000

† Loads are based on a safety factor of 5 to 1.

Available with hot galvanized or self-colored finish.
Eye, Jaw and Hook fittings are heat treated.

Diameter & Take-up	Hook and Eye		Closed Length	Weight per 100 in Lbs.
	Part No. SC	Galv.		
1/4" x 4"	01555 4	01705 3	8-1/4"	35
5/16" x 4-1/2"	01560 8	01710 7	9-1/4"	47.5
3/8" x 6"	01565 3	01715 2	11-3/4"	90.6
1/2" x 2"	01570 7	01720 6	9-1/4"	109
1/2" x 6"	01573 8	01723 7	13-5/8"	170
1/2" x 9"	01576 9	01726 8	16-3/8"	202
1/2" x 12"	01579 0	01729 9	19-5/8"	232.5
5/8" x 6"	01584 4	01734 3	14-1/8"	260
5/8" x 9"	01587 5	01737 4	17-3/8"	320
5/8" x 12"	01590 5	01740 4	20-5/8"	392.5
5/8" x 18"	01593 6	01743 5	26-5/8"	557
3/4" x 6"	01598 1	01748 0	15-3/4"	397.5
3/4" x 9"	01601 8	01751 0	18-7/8"	512.5
3/4" x 12"	01604 9	01754 1	22-1/8"	581
3/4" x 18"	01607 0	01757 2	28-1/8"	666
7/8" x 6"	01612 4	01762 6	18-1/2"	650
7/8" x 12"	01615 5	01765 7	23-1/8"	787.5
7/8" x 18"	01618 6	01768 8	29-1/8"	1212
1" x 6"	01623 0	01773 2	19-1/2"	805
1" x 12"	01626 1	01776 3	25-1/4"	1077.5
1" x 18"	01629 2	01779 4	31-1/4"	1386

To ascertain extended length add amount of take-up to length in closed position.

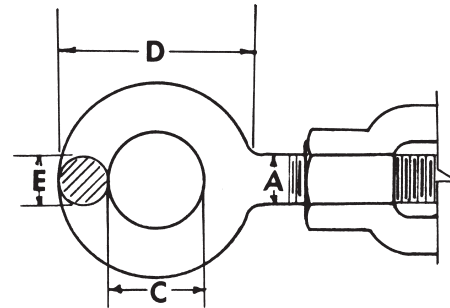

EYE DIMENSIONS - STRENGTH

Dimensions - Inches				Working Load Limit in Lbs. †
A	C	D	E	
1/4"	1/2"	1"	7/32"	500
5/16"	5/8"	1-1/4"	9/32"	800
3/8"	3/4"	1-1/2"	11/32"	1,200
1/2"	1"	2"	7/16"	2,200
5/8"	1-1/4"	2-5/16"	17/32"	3,500
3/4"	1-1/2"	2-3/4"	5/8"	5,200
7/8"	1-3/4"	3-1/2"	7/8"	7,200
1"	2"	3-3/4"	7/8"	10,000

† Loads are based on a safety factor of 5 to 1.

Maximum load ratings are based on a straight vertical lift in a gradually increasing manner. Any deviations as angular lifts, shock loads, modification of the basic part, etc., will result in drastically reduced maximum loads.

DROP FORGED TURNBUCKLES



Turnbuckles Meet Performance Requirements of ASTM Specification F1145-92 Type 1 Grade 1
(Supercedes FF-T-791B)

Eye, Jaw and Hook fittings are heat treated.



Diameter & Take-up	Jaw and Eye Hot Galvanized			Jaw and Jaw Hot Galvanized		
	Part No.	Closed Length	Weight per 100	Part No.	Closed Length	Weight per 100
1/4" x 4"	02605 5	8-1/4"	37.5	03055 7	8-1/2"	40
5/16" x 4-1/2"	02610 9	9-1/8"	52.5	03060 1	9-1/4"	52.5
3/8" x 6"	02615 4	11-1/2"	96.5	03065 6	11-1/2"	97.5
1/2" x 2"	02620 8	8-3/4"	109	03070 0	8-7/8"	119
1/2" x 6"	02623 9	13-1/4"	160	03073 1	13-1/2"	170
1/2" x 9"	02626 0	16-1/4"	198.5	03076 2	16-1/2"	202.5
1/2" x 12"	02629 1	19-1/4"	225	03079 3	19-1/2"	227.5
5/8" x 6"	02634 5	14-5/8"	257.5	03084 7	15-3/4"	260.5
5/8" x 9"	02637 6	17-7/8"	330	03087 8	18-3/4"	330
5/8" x 12"	02640 6	21-1/8"	402	03090 8	21-3/4"	407
5/8" x 18"	02643 7	27-1/8"	581	03093 9	27-3/4"	607
3/4" x 6"	02648 2	15-5/8"	402.5	03098 4	16-1/2"	417.5
3/4" x 9"	02651 2	18-3/4"	522.5	03101 1	19-1/2"	545
3/4" x 12"	02654 3	22"	602.5	03104 2	22-1/2"	619.5
3/4" x 18"	02657 4	28"	702	03107 3	28-1/2"	753
7/8" x 6"	02662 8	19"	655	03112 7	19-1/2"	668
7/8" x 12"	02665 9	23-1/2"	842.5	03115 8	24-1/2"	862.5
7/8" x 18"	02668 0	29-1/2"	1252	03118 9	30-1/2"	1281
1" x 6"	02673 4	19-1/8"	872	03123 3	21-3/16"	911
1" x 12"	02676 5	25-1/4"	1137.5	03126 4	25-1/2"	1165
1" x 18"	02679 6	31-1/4"	1463	03129 5	31-1/2"	1518



(Class H)



(Class G)

Available with hot galvanized or self-colored finish. Jaw types supplied with round pins and cotter keys unless nuts and bolts are specified. Locking nuts are also available.

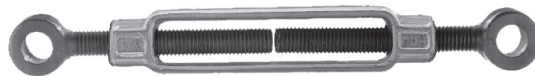

Diameter & Take-up	Rod End Eye & Eye Self-Colored		
	Part No.	Closed Length	Weight per 100
1/2" x 6"	03373 2	13"	131
5/8" x 6"	03384 8	13-1/4"	205
3/4" x 6"	03398 5	13-1/2"	293
7/8" x 6"	03412 8	14"	456
1" x 6"	03423 4	14-1/8"	589

JAW DIMENSIONS - STRENGTH

Dimensions - Inches								Working Load Limit in Lbs.†
A	B	C	D	*E	F	**H	P	
1/4"	7/32"	5/16"	25/32"	3/8"	5/8"	9/32"	1/4"	500
5/16"	1/4"	5/16"	7/8"	15/32"	5/8"	9/32"	1/4"	800
3/8"	9/32"	13/32"	1"	1/2"	13/16"	11/32"	5/16"	1,200
1/2"	5/16"	1/2"	1-9/32"	5/8"	1"	15/32"	7/16"	2,200
5/8"	3/8"	21/32"	1-21/32"	7/8"	1-5/16"	35/64"	1/2"	3,500
3/4"	1/2"	13/16"	1-27/32"	15/16"	1-5/8"	43/64"	5/8"	5,200
7/8"	9/16"	29/32"	1-31/32"	1-5/32"	1-7/8"	25/32"	3/4"	7,200
1"	11/16"	1-1/16"	2-13/32"	1-3/16"	2"	15/16"	7/8"	10,000

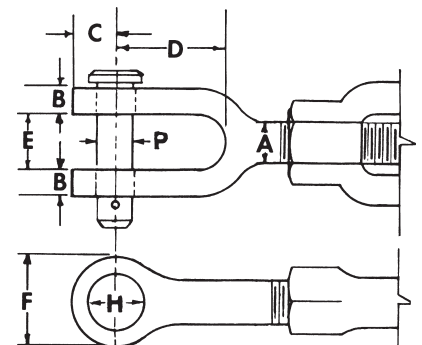

* At parting line: includes 7° draft.

** Hole size.

† Loads are based on a safety factor of 5 to 1.